

dolle.de/atlanta

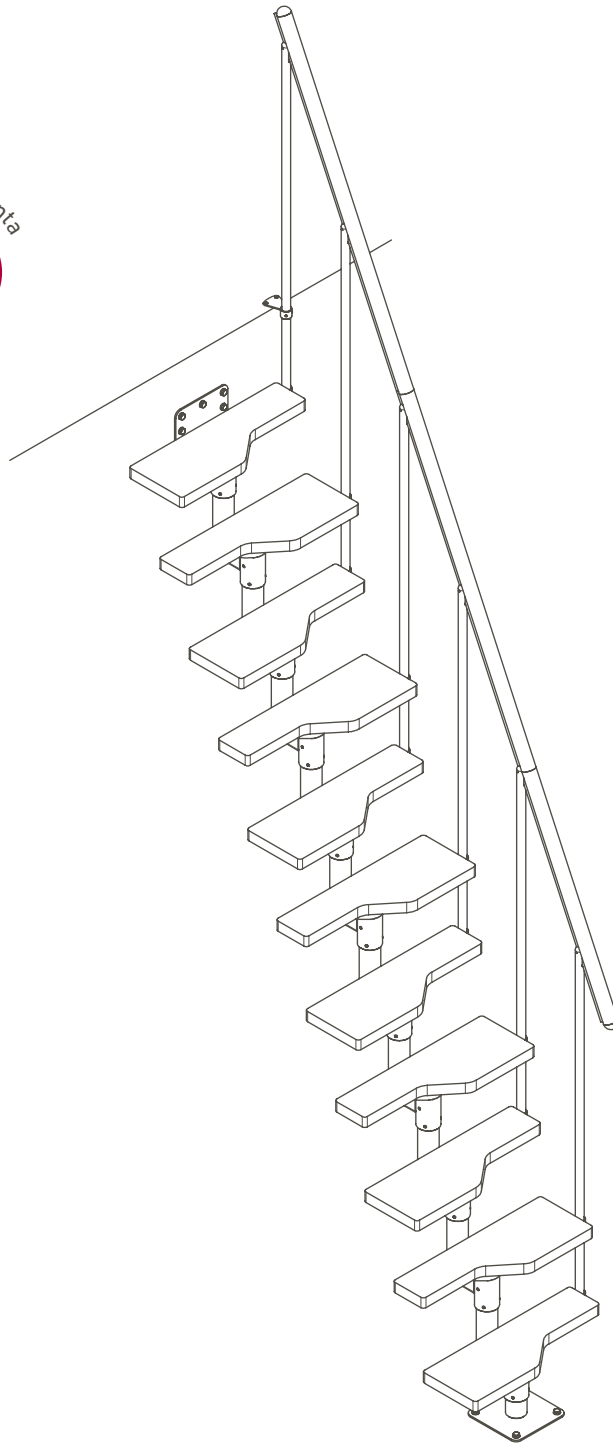

ATLANTA

MASSE

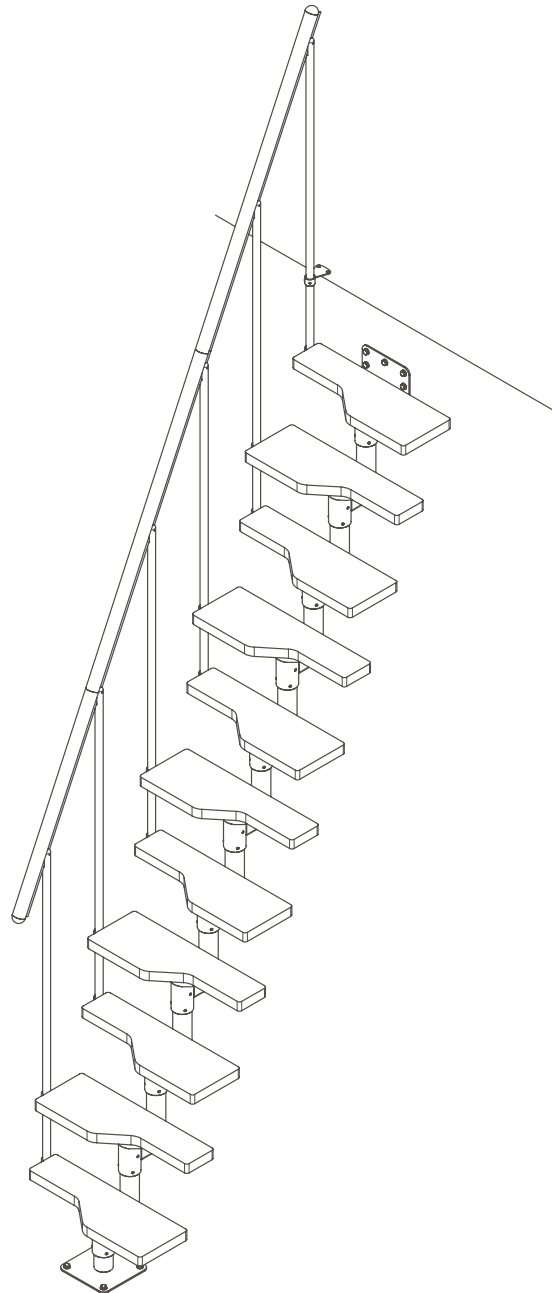
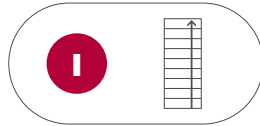

 Video: www.dolle.de/atlanta

BEZEICHNUNGEN

C1

E

G

H

M

| | | | | | |
|---|--------------------------------|--------------|------------------|-----------------------|-----------------------------------|
|  | Staircase width w. 1 banister | Headroom | Going (of tread) | Height floor-to-floor | Upper floor opening length - min. |
|  | Escalier à 1 rampe | Echappée | Giron | Hauteur sol-sol | Longueur de trémie min. |
|  | Trappe bredde m. 1 gelænder | Frihøjde | Grund | Etagehøjde | Hulmål længde min. |
|  | Trappbredd med 1 räcke | Frihöjd | Grund | Golv till golv höjd | Hålmått längd min. |
|  | Treppenbreite inkl. 1 Geländer | Kopffreiheit | Auftrittsbreite | Geschosshöhe | Öffnungsgröße länge min. |





N

O

P

R

R1

| | | | | | |
|---|----------------------------------|---------------|---------------------|------------------------|-----------------------|
|  | Upper floor opening width - min. | Clear width | Pitch | Total going length | Total going width |
|  | Largeur de trémie min. | Largeur utile | Pente de l'escalier | Recul total - longueur | Recul total - largeur |
|  | Hulmål bredde min. | Fri bredde | Stjghed/hældning | Udladning længde | Udladning bredde |
|  | Hålmått bredd min. | Fri bredd | Hällning | Trapplängd | Trappbredd |
|  | Öffnungsgröße breite min. | Durchgangsmaß | Winkel | Ausladung länge | Ausladung breite |

S

T

V

W

X

| | | | | | |
|---|-------------------|-------------------|----------------------|-------------------|---------------------|
|  | Rise height | Number of treads | Tread depth | Tread width | Tread thickness |
|  | Hauteur de marche | Nombre de marches | Profondeur de marche | Largeur de marche | Epaisseur de marche |
|  | Stigningshøjde | Antal trin | Trin dybde | Trin bredde | Trin tykkelse |
|  | Stigningshöjd | Antal steg | Stegdjup | Stegbredd | Stegjocklek |
|  | Steigungshöhe | Anzahl Stufen | Stufen tiefe | Stufen breite | Stufen Stärke |

Z

| | |
|---|--------------------|
|  | Deck thickness |
|  | Epaisseur de dalle |
|  | Dæk tykkelse |
|  | Bjälklagstjocklek |
|  | Deckenstärke |

MASSE

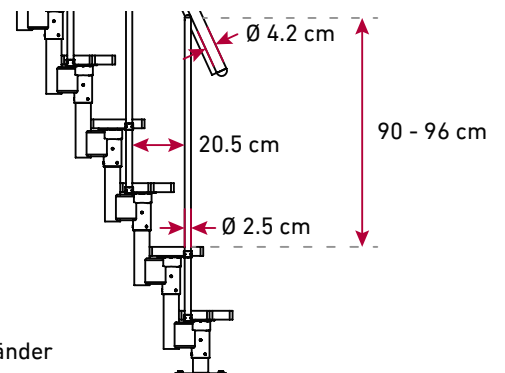
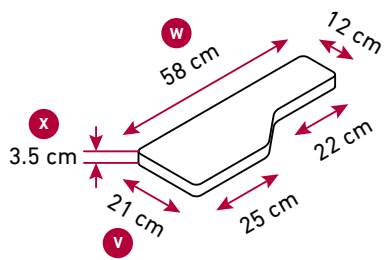
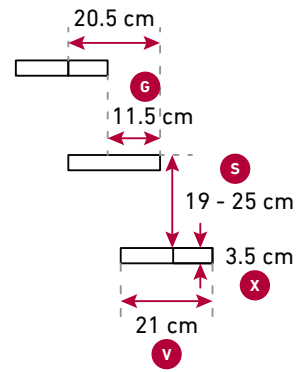
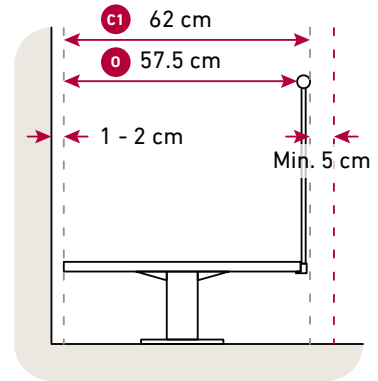
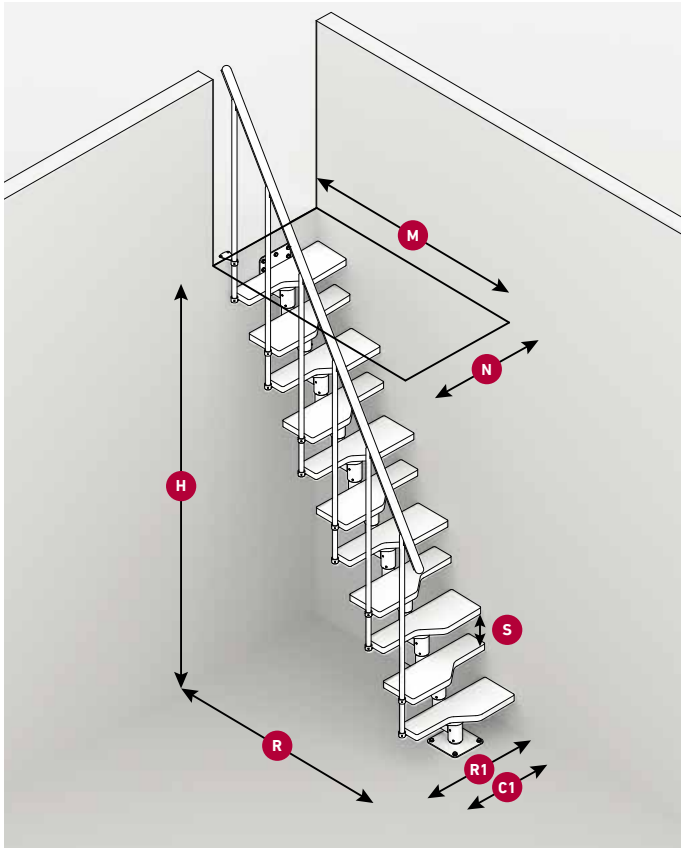

Einzelstabgländer

MASSE

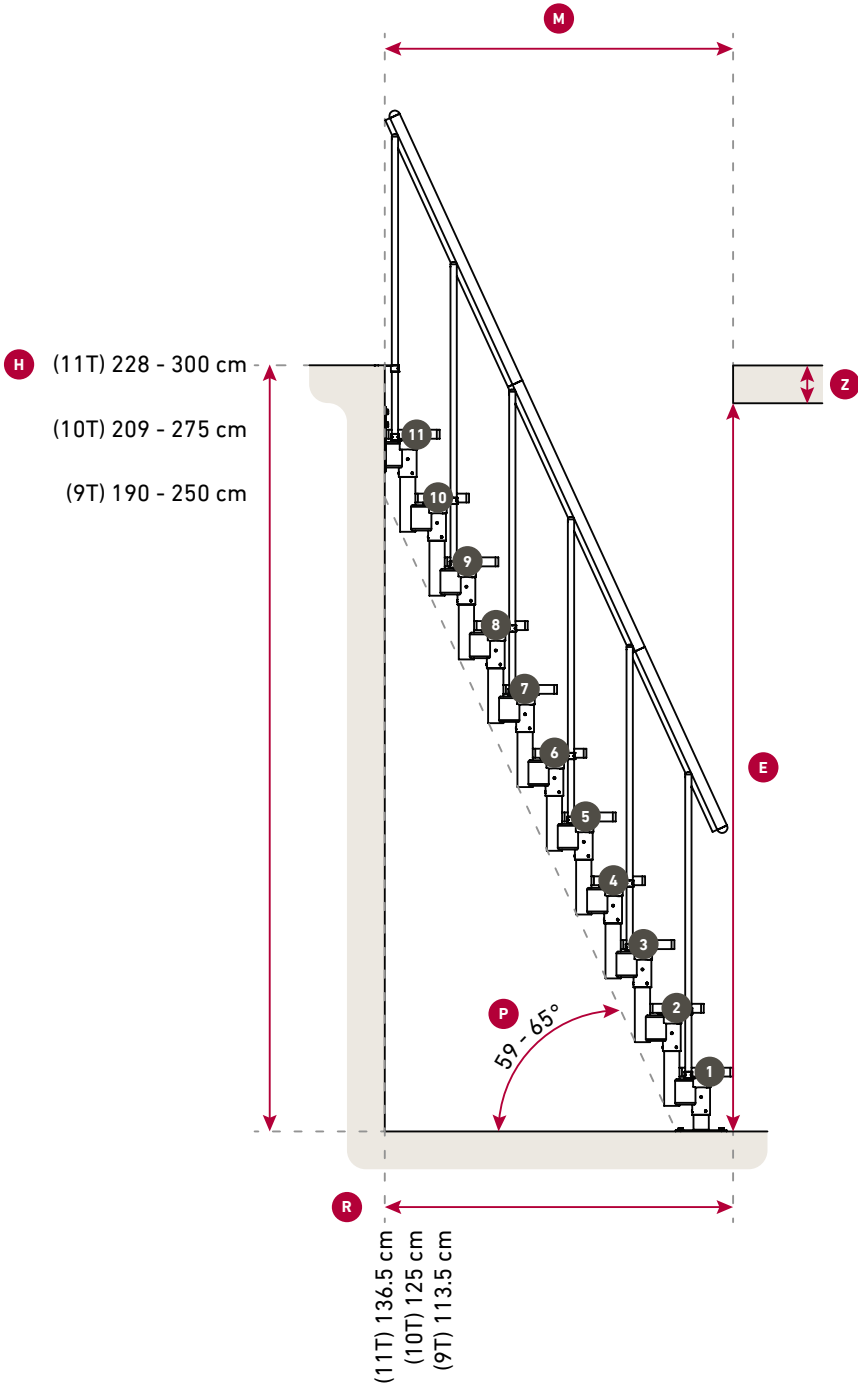

ATLANTA 11 STUFEN

H 228 - 300 cm

— Treppenmaße inkl. einseitigem Geländer

- - - Die Größe der Deckenöffnung in diesen Beispielen basiert auf den Annahmen: 5 cm Abstand für die Hand, 19 cm Steigungshöhe, 25 cm Deckenstärke, 200 cm Kopfhöhe.

